



260 A

2,5 t





CE

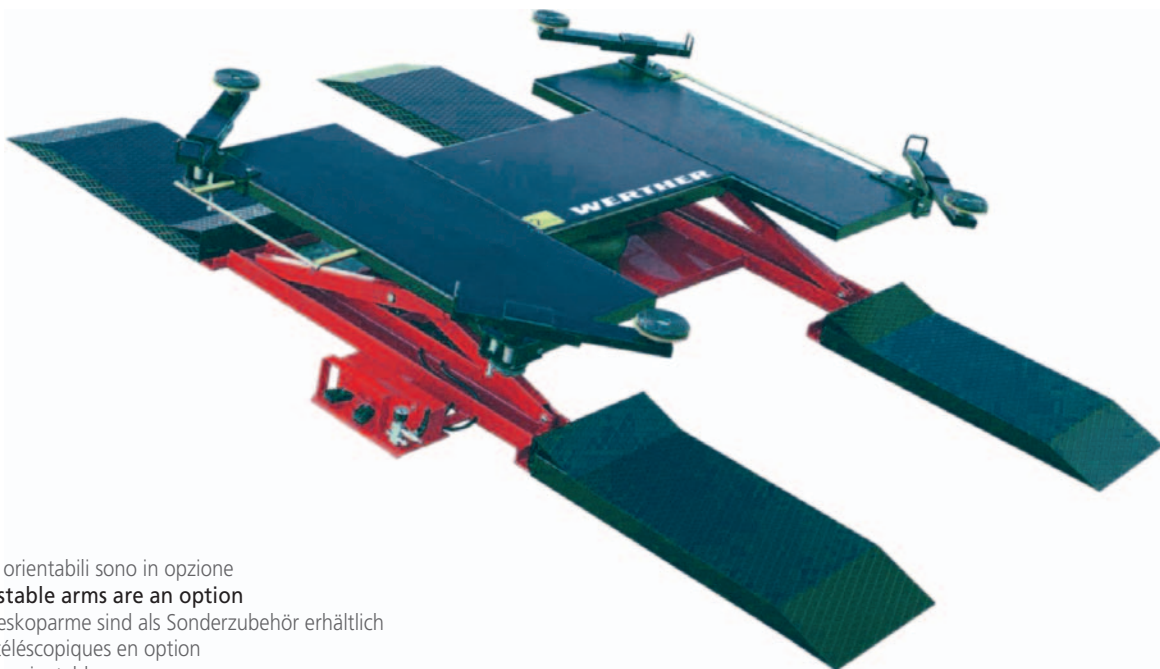

-  Pedana pneumatica per gommisti
-  Pneumatic tyre shop platform
-  Pneumatischer Scherenheber für den Reifenservice
-  Pont pneumatique pour spécialistes de pneus
-  Plataforma neumática para taller de neumáticos



Bracci telescopici orientabili sono in opzione
Telescopic adjustable arms are an option
Schwenkbare Teleskoparme sind als Sonderzubehör erhältlich
Bras orientables télescopiques en option
En opción, brazos orientables

-  Rampe di salita e discesa a doppio scalino • Facilissima installazione • Necessita solo di un attacco aria • Progettato e costruito originariamente per il gommista, trova applicazione preferenziale anche per una vasta gamma di operazioni su ogni tipo di veicolo
-  **Two step drive on and drive off ramps • Easy to install • Only a pneumatic connection required • Originally designed for tyre centers, this platform has become a multi-purpose equipment for all jobs, which call for a safe lifting platform.**
-  Zweistufen- Auf- und Abfahrampen • Einfachste Installation • Nur Druckluftanschluß notwendig • Ursprünglich für den Reifenservice entwickelt, wird heute diese Bühne für die verschiedensten Arbeiten eingesetzt, die eine sichere Kurzhubbühne erfordern.
-  Rampes de montée et descente à double marche • Très facile à installer • Ne nécessite que d'une prise d'air comprimé • Pensé et construit à l'origine pour le spécialiste du pneu, il s'utilise aussi pour une large gamme d'opérations sur tous types de voitures.
-  Rampas de elevación/descenso con doble escalón • Instalación sumamente fácil • Necesita tan solo una conexión de aire comprimido • Diseñada y construida originalmente para el taller de neumáticos, se utiliza también para una gran variedad de operaciones con todo tipo de vehículos

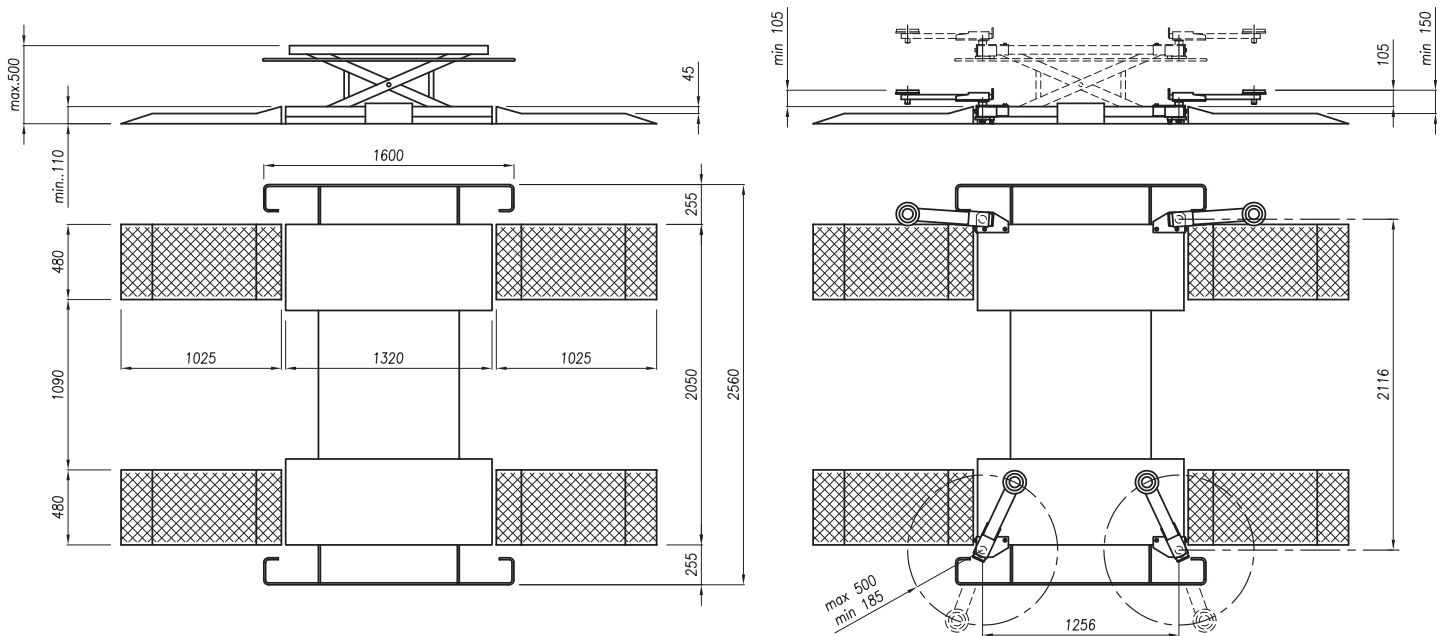

Dati tecnici

Technical data

Technische Eigenschaften

Caractéristiques techniques

Datos técnicos

Portata • Capacity • Tragfähigkeit • Capacité • Capacidad	2.500 kg
Peso • Weight • Gewicht • Poids • Peso	330 kg
Salita/Discesa • Lifting/lowering • Hub/Senkzeit • Levage/descente • Subida/bajada	15 s
Altezza di sollev. • Lifting height • Hubhöhe • Hauteur de levage • Altura de elevación	500 mm
Lunghezza • Length • Länge • Longueur • Longitud	450 kg
Larghezza max. • Overall width • Breite • Largeur • Ancho máx.	3410 x 2560 mm
Motore • Motor • Motorleistung • Puissance moteur • Motor	10/12 bar

Opzioni

Optionals

Sonderzubehör

Options

Opcionales

- Bracci telescopici orientabili
- Telescopic adjustable arms
- Schwenkbare Teleskoparme
- Bras orientables téléscopiques
- Brazos telescópicos orientables



The company reserves the right to introduce improvements in design or specification without prior notice