







430 BL





4,0 t

CE



-  Sollevatore elettroidraulico a 4 colonne con incavi anteriori e piastre oscillanti posteriori per allineamento ruote
-  Electro-hydraulic 4 post lift with front recesses and rear slip plates for wheel alignment
-  Elektrohydraulische 4-Säulen-Hebebühne mit vorderen Aussparungen und hinteren Schiebepplatten für die Achsvermessung
-  Pont élévateur électro-hydraulique à 4 colonnes avec encastremets avant et plaques arrière pour géométrie
-  Elevador electro-hidráulico de 4 columnas con asientos delanteros y platos oscilantes traseros para alineación de las ruedas



-  Sicurezza idraulica contro il sovraccarico • Valvola regolazione discesa • Segnale acustico ultimo tratto di discesa • Sicurezza idraulica in caso di rottura tubi idraulici • Comandi uomo presente 24 V • Sgancio elettrico del sistema di sicurezza meccanico
-  Overload safety valve • Descent control valve • "Buzzer" on last portion of descent • Pipe burst safety valve • 24 V, low tension dead man controls • Automatic release of safety locking devices
-  Überdruckventil als Überlastsicherung • Senksteuerventil • Akustisches Signal im letzten Teil der Senkbewegung • Rohrbruch-Sicherheitsventil • 24 V-Totmannschaltung • Elektrische Entriegelung der mechanischen Lastsicherung
-  Vanne de surpression contre surcharges • Vanne de réglage descente • Signal sonore sur la dernière partie de descente • Vanne d'arrêt en cas de rupture de la tuyauterie • Commandes de type homme mort à 24 V • Déverrouillage électrique du système de sécurité mécanique
-  Seguridad hidráulica contra la sobrecarga • Válvula de regulación del descenso • Señal acústica último tramo de descenso • Seguridad hidráulica en caso de rotura tubos hidráulicos • Mandos de hombre presente, 24V • Desenganche eléctrico del sistema de seguridad mecánico

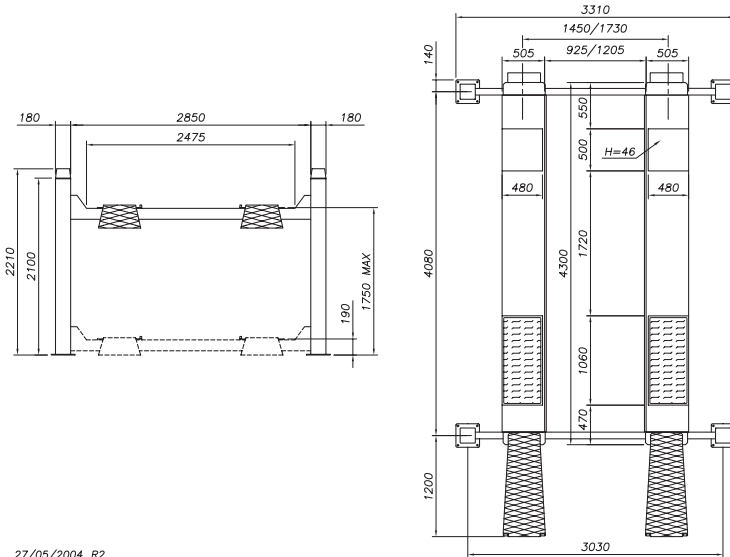

27/05/2004_R2

Dati tecnici	Technical data	Technische Eigenschaften	Caractéristiques techniques	Datos técnicos	
Portata	Capacity	Tragfähigkeit	Capacité	Capacidad	4.000 kg
Peso	Weight	Gewicht	Poids	Peso	910 kg
Salita/Discesa	Lifting/descent	Hub/Senkzeit	Levage/descente	Subida/Bajada	50/45 s
Altezza di sollevamento	Lifting height	Hubhöhe	Hauteur de levage	Altura de elevación	1750 mm
Motore	Motor	Motorleistung	Puissance moteur	Motor	2,2 kW - 3 ph 230 400V/50 Hz

Funzionamento: Elettroidraulico • **Function: Electro-hydraulic** • Funktionsweise: Elektrohydraulisch • Fonctionnement: Electrohydraulique • Funcionamiento: Electro-hidráulico

Opzioni **Optionals** **Sonderzubehör** **Options** **Opcionales**



Traversa idraulica ausiliaria (vedere scheda specifica)
 Hydraulic jacking beam (see relevant data sheet)
 Hydraulischer Radfreiheber (s. eigenes Datenblatt)
 Levage auxiliaire hydraulique (voir fiche technique)
 Elevador hidráulico auxiliar (ver ficha técnica)



Piatti Rotanti
 Radius plates
 Drehplatten
 Plaques pivotantes
 Platos giratorios

Esecuzione con motore monofase • Kit illuminazione • Coperchi per incavi anteriori • Carter protezione centralina
 Single-phase motor • Illumination kit • Cover for control unit • Cover for control unit
 Ausführung mit Einphasenmotor • Beleuchtungsset • Abdeckung für Hydraulikaggregat • Abdeckung für Hydraulikaggregat
 Moteur monophasé • Kit d'éclairage • Carter protection centrale hydraulique • Carter protection centrale hydraulique
 Motor monofásico • Kit de iluminación • Cubierta protectora para la centralita • Cubierta protectora para la centralita

The company reserves the right to introduce improvements in design or specification without prior notice