







# STRATOS 536



3,6 t

CE



-  Ponte elettroidraulico a forbice da incasso
-  Electro-hydraulic recessed scissor lift
-  Elektrohydraulische Bodeneinbau-Scherenhebebühne
-  Pont ciseaux électro-hydraulique encastré
-  Elevador electro-hidráulico de tijera a empotrar





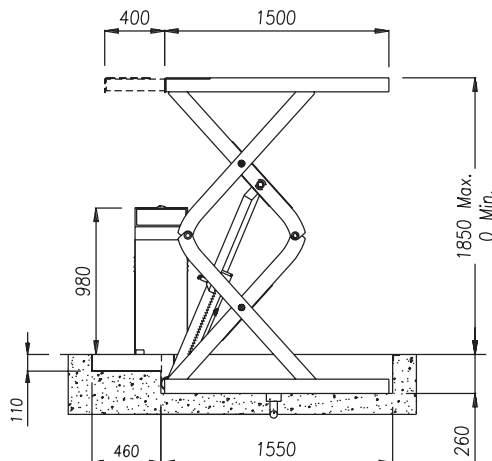
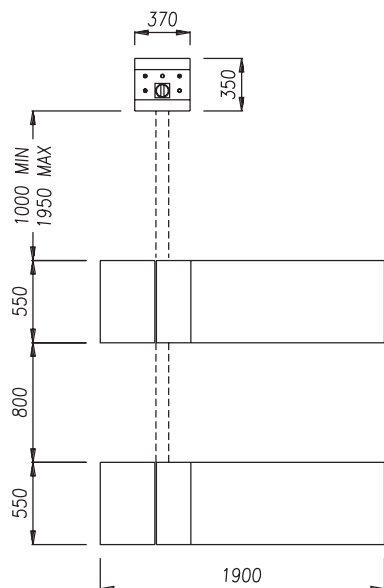

-  Sincronismo idraulico delle pedane • Sicurezza idraulica in caso di sovraccarico • Sicurezza idraulica in caso di rottura dei tubi • Sicurezza meccanica a cremagliera • Pompa manuale in caso di assenza di energia elettrica • Comandi uomo presente 24V • Serie 4 tamponi in gomma • Segnale acustico ultimo tratto di discesa
-  Hydraulic synchronization of platforms • Overload safety-valve • Safety-valve in case of sudden loss of pressure • Mechanical safety ratchet • Manual descent pump in case of power failures • "Dead man" controls 24V • Set of 4 rubber pads • 'Buzzer' on last portion of descent
-  Hydraulische Gleichlaufregulierung der Fahrschienen • Überlastsicherung mittels Überdruckventil • Rohrbruchsicherung • Mechanische Sicherung gegen unbeabsichtigtes Absenken (Zahnstangen) • Pumpe zum manuellen Absenken bei Stromausfall • Totmann-Steuerung (24 V-Niederspannung) • 4 Fahrzeugaufnahme-Gummiblöcke • Akustisches Signal im letzten Teil der Senkbewegung
-  Synchronisation hydraulique des plateformes • Sécurité hydraulique en cas de surcharge • Sécurité hydraulique en cas de rupture de tuyauterie • Sécurité mécanique par crémaillères • Pompe manuelle de descente en cas de coupure de courant • Commandes de type "homme mort" à 24V • Jeux de 4 taquets en caoutchouc • Signal sonore sur la dernière partie de descente
-  Sincronización hidráulica de las plataformas • Seguridad hidráulica contra sobrecarga • Seguridad hidráulica en caso de rotura tubos • Seguridad mecánica de cremallera • Bomba manual en caso de corte de energía eléctrica • Mandos de hombre presente, 24V • Juego de 4 tacos en goma • Señal acústica último tramo de descenso



Per la realizzazione di opere civili chiedere disegni di dettaglio.

Please ask for detailed drawings to create basement foundations.

Para la realización de obras civiles preguntar dibujo tecnico con detalle.

 <b>Dati tecnici</b>	 <b>Technical data</b>	 <b>Technische Eigenschaften</b>	 <b>Caractéristiques techniques</b>	 <b>Datos técnicos</b>
Funzionamento • <b>Operation</b> • Funktionsweise • Fonctionnement • Funcionamiento			Elettroidraulico • <b>Electro-hydraulic</b> • Elektrohydraulisch • Électrohydraulique • Electro-hidráulico	
Portata • <b>Capacity</b> • Tragfähigkeit • Capacité • Capacidad				3.600 kg
Peso • <b>Weight</b> • Gewicht • Poids • Peso				700 kg
Salita/Discesa • <b>Lifting/lowering</b> • Hub/Senkzeit • Levage/descente • Subida/bajada				45 s
Altezza di sollev. • <b>Lifting height</b> • Hubhöhe • Hauteur de levage • Altura de elevación				1850 mm*
Motore • <b>Motor</b> • Motorleistung • Puissance moteur • Motor				3 kW - 230-400 V/50 Hz
Alimentazione pneumatica • <b>Pneumatic feed</b> • Betriebsdruck • Alimentation pneumatique • Alimentación neumática				6 - 8 bar

\*: dal pavimento / **from floor** / ab Boden / du sol / desde el suelo

Installazione standard da incasso  
**Recessed installation as standard**  
 Einbauversion in Grube ist Standard  
 Installation encastrée standard  
 Instalación estándar para empotrar

 <b>Opzioni</b>	 <b>Optionals</b>	 <b>Sonderzubehör</b>	 <b>Options</b>	 <b>Opcionales</b>
--	--	--	--	---

Traverse per veicoli speciali • Prolunghe per tubi idraulici 2 m • Esecuzione monofase • Telaio ad incasso  
**Crosspieces for special vehicles • Hose extensions 2 m • Single phase version • Embedding frame • Traverses pour véhicules spéciaux**  
 Traversen für Sonderfahrzeuge • Schlauchverlängerungen 2 m • Einphasige Ausführung • Metallrahmen für Grube  
 Rallonges pour tuyaux hydrauliques 2 m • Version monophasée • Cadre de montage en encastrément  
 Travesaños para vehículos especiales • Prolongaciones para tubos hidráulicos 2m • Motor monofásico • Estructura para empotrar