







# 403M/403P

# 3,0 t



-  Traverse idrauliche
-  Hydraulic jacking beams
-  Hydraulische Achsfreiheber
-  Traverses hydrauliques
-  Travesaños hidráulicos



 **Modelli disponibili**  **Available versions**  **Lieferbare Ausführungen**  **Versions Disponibles**  **Versiones disponibles**

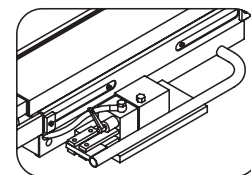
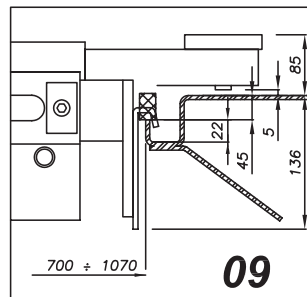
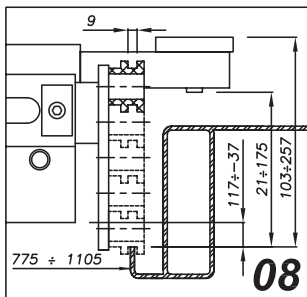
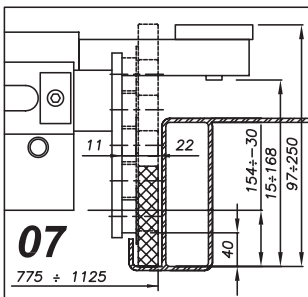
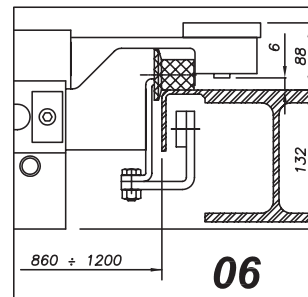
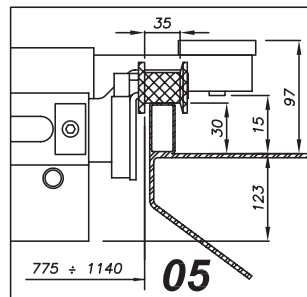
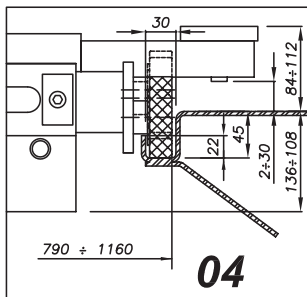
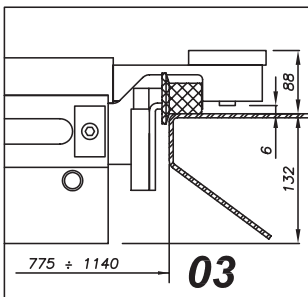

Pompa manuale  
 Pompe manuelle  
 Manual pump  
 Handpumpe

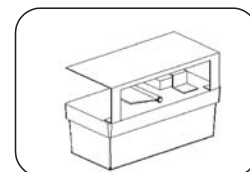

Pompa pneumatica  
 Pompe pneumatique  
 Pneumatic pump  
 Pneumatischer Pumpe

 Rullo/Galet/Roller/Rolle

 Sollevatore/Pont élévateur/Lift/Säulen

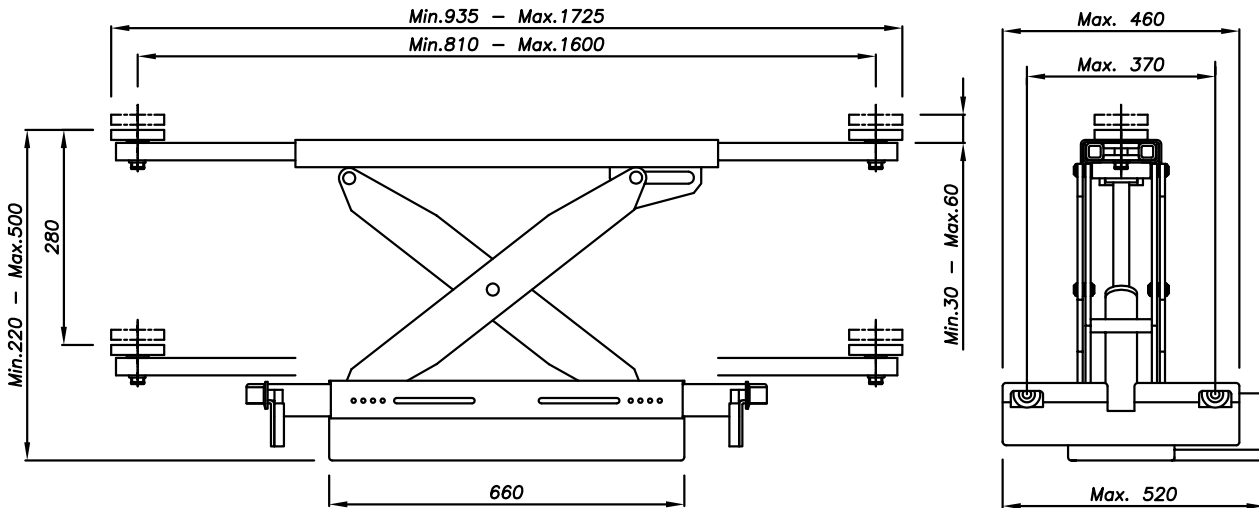

<b>Dati tecnici</b>	<b>Technical data</b>	<b>Technische Eigenschaften</b>	<b>Caractéristiques techniques</b>	<b>Datos técnicos</b>	
Portata	Capacity	Hubkraft	Capacité	Capacidad	3.000 kg
Spostamento vert. del carico	Lifting height	Hubhöhe	Hauteur de levée	Desplazamiento vert. de la carga	280 mm
Estensione min (bracci chiusi)	Min extension (arms retracted)	Min. Aufnahmebreite (Arme voll eingefahren)	Extension min. des bras (bras rentrés)	Extensión mín. (brazos cerrados)	935 mm
Estensione max. (bracci aperti)	Max. extension (arms extracted)	Max. Aufnahmebreite (Arme voll ausgefahren)	Extension max des bras (bras sortis)	Extensión máx. (brazos abiertos)	1.725 mm
Scartamento delle ruote di scorrimento	Gauge	Spurweite	Ecartement des roulettes	Ancho de vía	vedere dettagli schemi - please refer to carriage diagrams
Peso della traversa	Weight	Gewicht	Poids	Peso del travesaño	135 kg

**Opzioni**    **Optionals**    **Sonderzubehör**    **Options**    **Opcionales**



<ul style="list-style-type: none"> <li>• Kit appoggi per traversa</li> <li>• <b>Support kit for jacking beam</b></li> <li>• Stützesatz für Achsfreiheber</li> <li>• Jeu de supports pour traverse</li> <li>• Kit soportes para travesaños</li> </ul>	L1166
--	-------



<ul style="list-style-type: none"> <li>• Estensioni per tamponi di sollevamento</li> <li>• <b>Lifting pad extensions</b></li> <li>• Hubspindelverlängerungen</li> <li>• Rallonges pour tampons de levage</li> <li>• Extensiones para tacos de elevación</li> </ul>	• 60 mm	L1198
	• 100 mm	L1277

The company reserves the right to introduce improvements in design or specification without prior notice